

## C6IPMBM2

Cooker size	60x60 cm
N. of cavities with energy label	1
Cavity heat source	ELECTRICITY
Hob type	Induction
Type of main oven	Thermo-ventilated
Cleaning system main oven	Pyrolitic
EAN code	8017709332600
Energy efficiency class	A



## Aesthetics











<b>Aesthetic</b>	Classica	<b>Type of control knobs</b>	Smeg Classic
<b>Series</b>	Sinfonia	<b>Controls colour</b>	Stainless steel
<b>Design</b>	Square design	<b>No. of controls</b>	6
<b>Colour</b>	Matt Black	<b>Serigraphy colour</b>	Silver
<b>Finishing</b>	Matt black	<b>Display name</b>	DigiScreen
<b>Command panel finish</b>	Enamelled metal	<b>Door</b>	With 2 horizontal strips
<b>Logo</b>	Assembled st/steel	<b>Glass type</b>	Eclipse
<b>Logo position</b>	Facia below the oven	<b>Handle</b>	Smeg Classic
<b>Upstand</b>	Yes	<b>Handle Colour</b>	Brushed stainless steel
<b>Hob colour</b>	Stainless steel	<b>Storage compartment</b>	Door
<b>Type of control setting hob</b>	Hybrid: Knobs + Touch	<b>Feet color</b>	Silver
<b>Hob LED colours</b>	Red		

## Programs / Functions main oven

No. of cooking functions 9

Traditional cooking functions

 Static	 Fan assisted	 Circulaire
 Turbo	 ECO Eco	 Small grill
 Large grill	 Fan grill (large)	 Fan assisted base

## Cleaning functions



Pyrolytic

## Hob options



Control lock	Yes	Minute minder	1
End cooking timer	4	Bridge option	Yes

## Hob technical features



**Total no. of cook zones** 4

Front left - Induction - single - 1.50 kW - Booster 2.00 kW - - Ø 18.0 cm

Rear left - Induction - single - 1.50 kW - Booster 2.00 kW - - Ø 18.0 cm

Rear right - Induction - single - 1.50 kW - Booster 2.00 kW - - Ø 18.0 cm

Front right - Induction - single - 1.50 kW - Booster 2.00 kW - - Ø 18.0 cm

<b>Number of Flexible zones</b>	2	<b>Minimum pan diameter indication</b>	Yes
<b>Automatic switch off when overheat</b>	Yes	<b>Selected zone indicator</b>	Yes
<b>Automatic pan detection</b>	Yes	<b>Residual heat indicator</b>	Yes

## Main Oven Technical Features



<b>No. of lights</b>	1	<b>Removable inner door</b>	Yes
<b>Fan number</b>	1	<b>Total no. of door glasses</b>	4
<b>Net volume of the cavity</b>	70 l	<b>No. of thermo-reflective door glasses</b>	3
<b>Gross volume, 1st cavity</b>	79 l	<b>Safety Thermostat</b>	Yes
<b>Cavity material</b>	Ever Clean enamel	<b>Heating suspended when door is opened</b>	Yes
<b>No. of shelves</b>	5	<b>Cooling system</b>	Tangential
<b>Type of shelves</b>	Metal racks	<b>Door Lock During Pyrolysis</b>	Yes
<b>Light type</b>	Halogen	<b>Usable cavity space dimensions (HxWxD)</b>	360X460X425 mm
<b>Light Power</b>	40 W	<b>Temperature control</b>	Electro-mechanical
<b>Cooking time setting</b>	Start and Stop	<b>Lower heating element power</b>	1200 W
<b>Light when oven door is open</b>	Yes	<b>Upper heating element - Power</b>	1000 W
<b>Door opening</b>	Flap down	<b>Large grill - Power</b>	2700 W
<b>Removable door</b>	Yes	<b>Circular heating element - Power</b>	2000 W
<b>Full glass inner door</b>	Yes	<b>Grill type</b>	Electric

## Options Main Oven

Timer	Yes	Minimum Temperature	50 °C
End of cooking acoustic alarm	Yes	Maximum temperature	260 °C

## Accessories included for Main Oven & Hob



Rack with back and side stop	2	Telescopic Guide rails, partial Extraction	1
40mm deep tray	1	Meat Probe	1
Grill mesh	1		

## Electrical Connection

Plug	Not present	Electric cable	Installed, Single phase
Electrical connection rating	10000 W	Additional connection modalities	Double and Three Phase
Current	44 A	Frequency	50/60 Hz
Voltage	220-240 V	Terminal block	5 poles
Voltage 2 (V)	380-415 V		

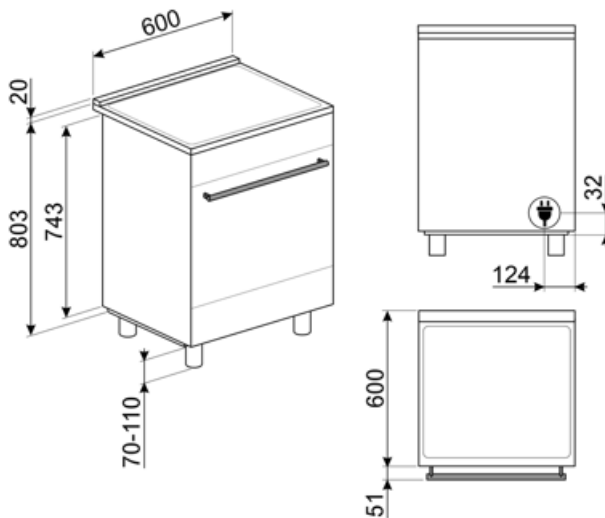

## Not included accessories

### AIRFRY

Air fryer rack AIRFRY . Ideal for recreating traditional frying in the oven, but with fewer calories and less fat. It allows you to cook quickly and simply dishes such as French fries, fried vegetables and fish, ensuring perfect browning and crispiness.



### BN620-1

Enamelled tray suitable for 45cm and 60cm ovens. Depth 20 mm. Perfect for a wide range of savoury and sweet baking.



### BNP608T

Teflon-coated tray, 8mm depth, to be placed on the grid



### GTP

Partially extractable telescopic guides (1 level), suitable for traditional ovens. Made in stainless steel, they guarantee stability and facilitate the smooth extraction of the trays.



### KITC6X

Splashback, 60cm, stainless steel, suitable for Master and Sinfonia cookers

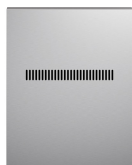

### PALPZ

Pizza shovel with folding handle. Dimensions L31.5 x H32.5 cm. Easy and convenient to use and store. Perfect for serving pizza, bread and savory pastries in a safe and professional way.



### SFLK1

Child lock



### BBQ

Double sided plate BBQ. Suitable for recreating succulent and crispy dishes in the oven with the typical taste of grilled cooking. The ribbed side is particularly suitable for meats and cheeses. The smooth side for fish, seafood and vegetables.



### BN640

Enamelled tray suitable for 45cm and 60cm ovens. Depth 540 mm. Perfect for cooking and roasting meat and fish in sauces. Also ideal for experimenting with lighter and crunchy side dishes

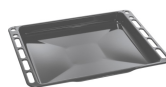

### GRILLPLATE

Universal griddle for induction, gas, ceramic and electric hobs. Non-stick surface ideal for cooking meat, cheese and vegetables. Dimensions: 410 x 240 mm.



### GTT

Totally extractable telescopic guides (1 level), suitable for traditional ovens. Made in stainless steel, they guarantee stability and facilitate the smooth extraction of the trays.



### KITPBX

Height reduction feet (850mm), st/steel, for Sinfonia and Master cookers (845-856mm)



### SCRP

Non-scratch hob scraper - suitable for induction and ceramic hobs



### SMOLD

Set of 7 silicone moulds for ice creams, ice lollies, pralines, ice cubes or to portion food. Usable from -60°C to +230°C

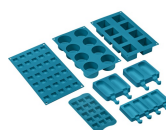

### STONE

















Rectangular refractory stone Ideal for cooking pizzas with the same results as a typical wood-fired oven. Can also be used for baking bread, focaccias and other recipes such as pies, flans or biscuits Dimensions:L42 x H1,8 x P37,5 cm.



### TPKPLATE

Universal plate for induction, gas, ceramic and electric hobs. Non-stick surface ideal for cooking fish, eggs and vegetables. Dimensions: 410 X 240 mm.

## Symbols glossary

 <p>Child lock: some models are fitted with a device to lock the programme/cycle so it cannot be accidentally changed.</p>	
 <p>Installation in column: Installation in column</p>	 <p>Air cooling system: to ensure a safe surface temperatures.</p>
 <p>Quadruple glazed: Number of glazed doors.</p>	 <p>Ever Clean Enamel: Ever Clean enamel is applied electrostatically, corner to corner and edge to edge to prevent cracking or cracks over time. It is a particular pyrolytic enamel, resistant to acids which, in addition to being pleasantly bright, promotes greater cleaning of the oven walls, thanks to its lower porosity. It is baked at over 850 ° C and slowly polymerized at a scientifically determined rate to ensure uniform depth and strength Ever Clean enamel creates an impeccable finish both on the inside of the oven and on the trays, making the surfaces of the oven incredibly easy to maintain over time as it reduces the adhesion of fat during cooking</p>
 <p>Fan assisted base: the mix of fan and lower heating element alone allows to finish cooking foods already cooked on the surface but not internally more quickly. This system is recommended to finish cooking foods that are already well cooked on the surface, but not internally, which therefore require a moderate higher heat. Ideal for any type of food.</p>	 <p>Fan assisted: Intense and homogeneous traditional cooking, also suitable for complex recipes. The fan is active and the heat comes from below and from above at the same time. Ventilated cooking ensures a faster and more homogeneous result, leaving fragrant foods outside and moister inside. Ideal for baked pasta, biscuits, roasts and cobblers.</p>
 <p>Static: Traditional cooking suitable for the preparation of one dish at a time. The fan is not active and the heat comes from below and from above at the same time. Static cooking is slower and more delicate, ideal in order to get well cooked and dry dishes even inside. Ideal for cooking all types of roasts, fatty meats, bread, filled cakes.</p>	 <p>Circulaire: it is the perfect function for cooking all types of dishes in a more delicate way. The heat comes from the back of the oven and is distributed quickly and evenly The fan is active. It is also ideal for cooking on multiple levels without mixing smells and flavors.</p>
 <p>ECO: low energy consumption cooking: this function is particularly suitable for cooking on a single shelf with low energy consumption. It is recommended for all types of food except those that can generate a lot of moisture (for example vegetables). To achieve maximum energy savings and reduce time, it is recommended to put the food in the oven without preheating the cooking compartment</p>	 <p>Grill: Very intense heat coming only from above from a double heating element. The fan is not active. Provides excellent grilling and gratinating results. Used at the end of cooking, it gives a uniform browning to dishes.</p>
 <p>Half grill: For rapid cooking and browning of foods. Best results can be obtained by using the top shelf for small items, the lower shelves for larger ones, such as chops or sausages. For half grill heat is generated only at the centre of the element, so is ideal for smaller quantities.</p>	 <p>Fan grill: very intense heat coming only from above from a double heating element The fan is active. It allows the optimal grilling of thickest meats. Ideal for large cuts of meat.</p>

- 

**Turbo:** the heat comes from 3 directions: above, below and from the back of the oven. The fan is active. It allows quick cooking, even on several shelves without mixing the aromas. Ideal for large volumes or foods that require intense cooking.



**Overheat protection:** The safety system that automatically turns off the hob in case of overheating of the control unit.
- 

**Induction:** The work of these hobs is based on the principle of electromagnetic induction. The heat is generated directly in the bottom of the pan during its contact with the hob.



**All glass inner door:** All glass inner door, a single flat surface which is simple to keep clean.
- 

**The inner door glass:** can be removed with a few quick movements for cleaning.



**Side lights:** Two opposing side lights increase visibility inside the oven.
- 

**Automatic opening:** some models have Automatic opening door when the cycle is finished which is a perfect solution for handle-less kitchen units as no handle is needed. For safety reasons, the door locks automatically when the machine is in use to avoid it being opened inadvertently.



**PYROLYSIS - AUTOMATIC CLEANING FUNCTION:** the oven heats up to a temperature approaching 500 ° C and chars grease and food residues into a fine ash that can be easily wiped off with a damp cloth. At such a high temperature, the door locks automatically for safety, while the temperature of the door remains controlled so it is safe to touch. User adjustable function based on the level of dirt present in the oven.
- 

**Indication of residual heat:** After the glass ceramic hob is switched off the residual heat indicator shows which of the heating zones still remains hot. When the temperature drops below 60 ° C, the indicator goes out.



**The oven cavity has 5 different cooking levels.**
- 

**Telescopic rails:** allow you to pull out the dish and check it without having to remove it from the oven entirely.



**Timer:** All ceramic hobs have a timer which automatically ends cooking after a preset time.
- 

**TWIN\_ZONE\_72dpi**



**The capacity indicates the amount of usable space in the oven cavity in litres.**
- 

**4.3 inch display with LED technology, usability with knobs + 3 touch keys**

## Benefit (TT)

---

### **True-convection**

The best cooking performances guaranteed by ventilated circular flow

Multiple fans and heating elements guarantee the perfect aerodynamic heat flow, allowing homogeneous and quicker cooking inside the cavity.

### **Induction hob**

Induction offers fast cooking and precise temperature control

Through the use of suitable cookware, induction is easy to use and maintain, safe and responsive.

### **Touch control**

Easy and intuitive timer setting with a single touch

### **Single turbine**

The oven has a fan equipped with a circular heating element allowing cooking with rotating heat

### **Isothermic Cavity**

The best cooking performance at the highest energy efficiency

### **Tangential cooling**

New cooling system with tangential fan and airflow from the door to the splashback

### **Pyrolysis**

Easy oven cleaning thanks to special pyrolytic function

### **Multilevel halogen light**

Internal halogen lighting on different levels guarantees excellent visibility

### **Telescopic guides**

Easy extraction and safe insertion of trays into the oven thanks to telescopic guides

### **Adjustable height**

Cooker top flushed with the working area thanks to adjustable feet

### **Removable inner glass**

Internal door glasses are easily removable for complete cleaning

### **Multilevel cooking**

Several cooking levels allow maximum flexibility of use



#### **Cold door**

During any function, the external door glass is cold, avoiding any risk of burns

#### **AirFry (AIRFRY optional accessory)**

Lighter and tastier food thanks to airfry basket (optional accessory)

#### **BBQ (optional accessory)**

Barbeque cooking directly in the oven with the double-sided grill (BBQ optional accessory)

#### **Pizza stone (optional accessory)**

Baking with refractory stone for soft and crispy pizza and yeast products (STONE optional accessory)

#### **Storage compartment**

More space thanks to the lower compartment, ideal for storing accessories or cooking utensils